

# Table of contents

<b>1. Introduction</b>	<b>4</b>
1.1. Variants	4
1.2. Explanation of warning symbols	4
1.3. Additional sources	4
1.4. Manufacturer's contact details	5
1.5. Overview of parts	5
<b>2. Product information</b>	<b>7</b>
2.1. Intended use	7
2.2. Unintended use	8
2.3. PPE Class II	8
<b>3. General safety instructions</b>	<b>9</b>
<b>4. Preparation</b>	<b>13</b>
4.1. Checking the contents of the box	13
4.2. Checking the part sizes	15
4.3. Labels and indications	16
4.4. Before use	19
<b>5. Installation</b>	<b>21</b>
5.1. Connecting the back connector	21
5.2. Connecting the torso structures	21
5.3. Connecting the torso structures to the hip frame	23
5.4. Installing the leg straps (optional)	23
5.5. Checking assembly	23
<b>6. Fitting</b>	<b>25</b>
6.1. Putting on and removing the FLEX	25
6.2. Adjusting the front vest	27
6.3. Aligning the hip frame and smart joints	29
6.4. Adjusting the length of the torso structure	31
6.5. Fitting the leg pads	33
6.6. Fitting the leg straps (optional)	35
6.7. Setting the angle of the smart joint	37
6.8. How a good fit looks and feels	39

<b>7.</b>	<b>Using the FLEX</b>	<b>41</b>
7.1.	Learn to use the FLEX	41
7.2.	First movements with the FLEX	43
7.3.	Lock and stow the belt straps	43
<b>8.</b>	<b>Daily use</b>	<b>45</b>
8.1.	Adjust the angle of the smart joint to the task	45
8.2.	Where to use the FLEX	47
<b>9.</b>	<b>Storage and transport</b>	<b>49</b>
<b>10.</b>	<b>Troubleshooting</b>	<b>50</b>
<b>11.</b>	<b>Maintenance</b>	<b>51</b>
11.1.	Life span of the Laevo FLEX	51
11.2.	Replacing the vest frame padding	53
11.3.	Replacing the front vest	55
11.4.	Replacing the hip padding	57
11.5.	Replacing the leg pads	59
11.6.	Replacing the actuator springs	61
11.7.	Replacing the lower bar	63
11.8.	Washing and cleaning	65
11.9.	Check regularly	65
11.10.	Repair and disposal	65
<b>12.</b>	<b>Legal information</b>	<b>66</b>
12.1.	Liability	66
12.2.	Warranty	66
12.3.	CE	66
<b>13.</b>	<b>Specifications</b>	<b>67</b>
13.1.	Technical specifications Laevo FLEX	67
13.2.	Technical specifications Torso Structures	67
<b>14.</b>	<b>Sizing tool</b>	<b>68</b>

# 1. Introduction

Thank you for choosing Laevo.

This document gives instructions for use, safety, fitting and maintenance of the Laevo FLEX.

- ▶ Read carefully before use.
- ▶ Keep for future reference.
- ▶ Follow the safety instructions.
- ▶ If you are not the only user, instruct all users in how to use of the product correctly and safely.

If you have questions, contact Laevo or your supplier.

## 1.1. Variants

All instructions are for the Laevo FLEX, version 3.0.

The illustrations are general examples. Your product can be different from the illustrations.

## 1.2. Explanation of warning symbols

<b>⚠ DANGER!</b>	Identifies possible life-threatening or disabling injury.
<b>⚠ WARNING!</b>	Identifies possible serious injury.
<b>⚠ CAUTION</b>	Identifies possible minor injury.
<b>ⓘ NOTE</b>	Identifies possible product damage.
<b>ⓘ TIP</b>	Information and tips to make it even easier to use the FLEX.

Get more tips at [www.laevo-exoskeletons.com](http://www.laevo-exoskeletons.com).

## 1.3. Additional sources

Find additional information and updates online at:

[www.laevo-exoskeletons.com](http://www.laevo-exoskeletons.com)  
[www.laevo-exoskeletons.com/flex](http://www.laevo-exoskeletons.com/flex)  
[www.laevo-exoskeletons.com/flex-training](http://www.laevo-exoskeletons.com/flex-training)  
[www.laevo-exoskeletons.com/register](http://www.laevo-exoskeletons.com/register)  
[www.laevo-exoskeletons.com/legal](http://www.laevo-exoskeletons.com/legal)



1.4. Manufacturer's contact details

	<p><b>Laevo BV</b>                  Patrijsweg 30                  2289 EX Rijswijk                  The Netherlands  <a href="http://www.laevo-exoskeletons.com">www.laevo-exoskeletons.com</a>                  +31 15 30 20 025</p>
---	--

1.5. Overview of parts

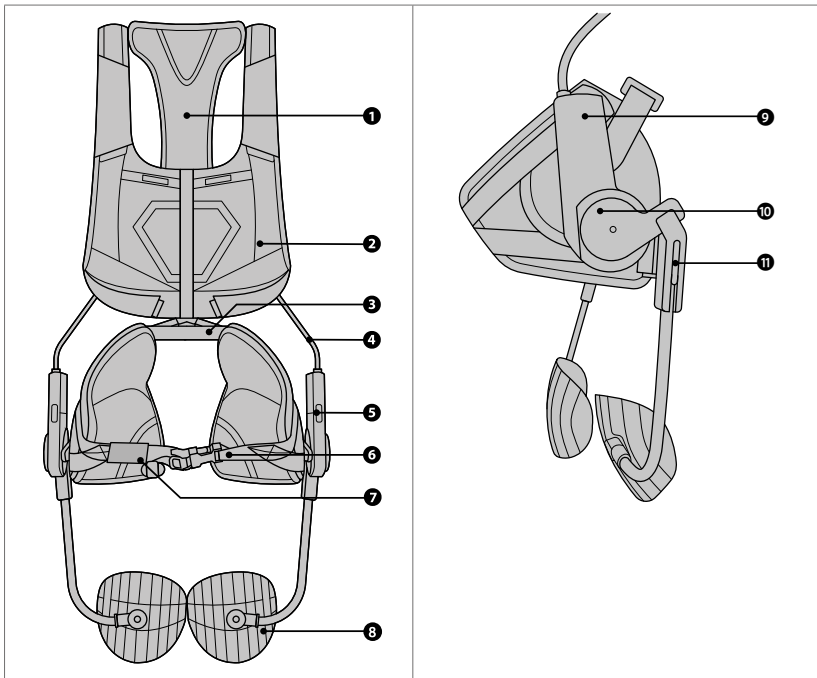

- 1 Vest frame
- 2 Front vest
- 3 Hip frame
- 4 Torso structures
- 5 Smart joint
- 6 Front belt
- 7 Font belt buckle sleeve
- 8 Leg pads
- 9 Actuator spring
- 10 Angle indicator (for smart joint)
- 11 Leg pad fixator

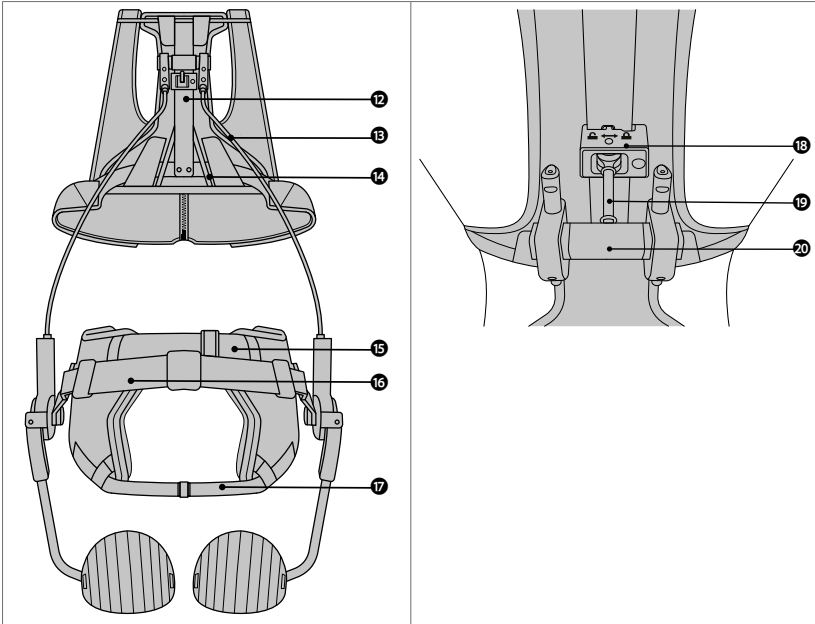

- 12 Vest frame
- 13 Torso structure
- 14 Lower bar
- 15 Upper back belt
- 16 Hip frame
- 17 Bottom belt
- 18 Back connector
- 19 Swivel arm (for back connector)
- 20 Back connector swivel

## 2. Product information

The FLEX is a wearable device which supports the body during work in various positions, for example, when you stoop, squat, bend forward or do repetitive lifting. The FLEX decreases the strain in the lower back during these activities.

The FLEX supports the lower back when you:

- Bend forward, hold this posture and return upright
- Squat and stoop
- Kneel
- Lift

### CAUTION

Do not lift heavier loads than permitted by law or company directives.

#### **Risk of injury to arms and other body parts**

- ▶ Do not use the FLEX to lift heavier loads than permitted by law or company directives.
- ▶ Do not use the FLEX to replace lifting aids for heavy loads.

The FLEX allows or partly supports your body when you:

- Stretch outward and upward
- Twist
- Walk, carry, walk up and down stairs.

It is possible to sit on a flat surface or chair without armrest, but you should not sit for long periods.

### WARNING!

Unintended activities

#### **Risk of unsafe situations**

Do not:

- ▶ Run
- ▶ Climb, work at heights
- ▶ Drive any vehicle (for example, a forklift).

Use the FLEX only for work.

For all technical specifications see chapter [13](#). Specifications

### **2.1. Intended use**

The FLEX is personal protective equipment (PPE) designed and manufactured to be worn by a person for protection against back injuries.

Use it when you want to:

- Reduce the risk of back injuries during work
- Reduce fatigue caused by repetitive bending or lifting
- Improve work comfort
- Increase work productivity.

If you are not sure about correct use, contact Laevo or your supplier.

The FLEX is intended for use at work. Do not use the FLEX if you are not sure the FLEX can be used at your work, during your work tasks or in your work environment.

## **2.2. Unintended use**

Do not use the FLEX:

- when you are driving a vehicle
- to carry heavier loads than you normally would
- as fall protection

Consult a physician before you use the FLEX if:

- you have a pacemaker
- you have breast implants
- your axillary lymph nodes have been removed

Consult a physician if you have or have had any of the following:

- Inguinal hernia
- Hernia
- Knee injury
- Hip replacement
- Knee replacement
- Hyper-extended knee
- Recent surgery
- Skin diseases/injury
- Inflammation
- Scars
- Skin reddening

ⓘ We do not know if these contra-indications will lead to discomfort or other risks. They have not been researched or tested. It can be safe to use the FLEX in combination with these contra-indications. Consult a physician for personal advice.

## **2.3. PPE Class II**

The FLEX is a Class II Personal Protective Equipment which means the FLEX protects against medium risks. The FLEX is designed to prevent back injuries.



# 3. General safety instructions

- ⓘ Consult the local regulations for the use of Personal Protective Equipment.

## **⚠ DANGER!**

Remove the FLEX from patient before CPR or defibrillation.

### **Reduced efficiency of CPR or defibrillator**

- ▶ Expose chest before CPR: Unzip the two halves of the vest. Release the buckle of the front belt. Push the halves outward.

## **⚠ WARNING!**

Do not put your fingers near the smart joint while you bend or carry the FLEX.

### **Incorrect use can lead to cutting or crushing injuries**

- ▶ Do not put your fingers near pivot points while you bend or carry the FLEX.
- ▶ Do not let other people put their fingers near the FLEX while it is used (except during setup).
- ▶ Keep the FLEX away from children and pets.

## **⚠ WARNING!**

Do not use the FLEX if it causes discomfort or pain.

### **Risk of increased discomfort or pain**

- ▶ Do not use the FLEX until the pain is gone.
- ▶ When the pain is gone, start to use the FLEX again and gradually increase the duration and frequency.
- ▶ Do not use the FLEX directly against the skin.

## **⚠ WARNING!**

Do not use the FLEX if it is damaged.

### **Loss of function, including sudden loss of support**

- ▶ Do not use a damaged FLEX.
- ▶ Do not use flammable substances (for example, matches, lighters, candles) near the FLEX. The FLEX is not flame retardant.
- ▶ Dry the FLEX after you use it.
- ▶ Clean the moving parts to remove sand, dust and debris.

## **⚠ WARNING!**

The FLEX can fail while you bend.

### **Risk of sudden torso, hand or head movement (a few centimetres)**

- ▶ Do not use the FLEX when a sudden hand or head movement could cause injury to you or someone else.

## **⚠ WARNING!**

Do not push the buttons while you bend.

### **Risk of sudden loss of support**

- ▶ Be careful not to accidentally push buttons, for example, by bumping.
- ▶ Do not push buttons on the FLEX while you use it.

## **⚠ WARNING!**

Do not use out-of-date or overloaded torso structures.

### **Risk of sudden loss of support**

- ▶ The serial number next to the date on the torso structure can be used to track these parts.

The serial number next to the date on the torso structure can be used to track these parts. Register the torso structures at [www.laevo-exoskeletons.com/register](http://www.laevo-exoskeletons.com/register) for specific advice on when to replace the structures.



- ▶ In general, the FLEX should not be used after the torso structures are more than three years old or have been used for 250.000 cycles.
- ▶ Contact the supplier and/or replace parts.

## **⚠ WARNING!**

Do not allow clothing or tools to be caught in the FLEX or between the FLEX and your body.

### **Risk of injury**

- ▶ Put on appropriate clothing. Do not put on clothing or accessories that have loose ends, for example, necklaces or scarves.
- ▶ Do not keep hard objects in your clothing or pockets under the FLEX.
- ▶ If something becomes caught in the FLEX, move slowly to release and remove it.

## **⚠ WARNING!**

Be careful that nothing pulls the structures while you use the FLEX.

### **Risk of loss of balance**

- ▶ Do not let anyone else put their hands on the FLEX while you use it.

**⚠ WARNING!**

Be careful that hair does not get caught in the back connector swivel or Velcro.

**Risk of pulled hair**

- ▶ If you have long hair, put your hair in a ponytail or bun.
- ▶ Move your hair to other side of your neck before you release any Velcro near the hair.

**⚠ WARNING!**

Use the FLEX correctly and do not make any changes.

**Change/loss of function or damage to the FLEX**

- ▶ Use the FLEX with care and only for its intended purpose.
- ▶ Do not make changes to parts of the FLEX.

The box contains the following, at a minimum:

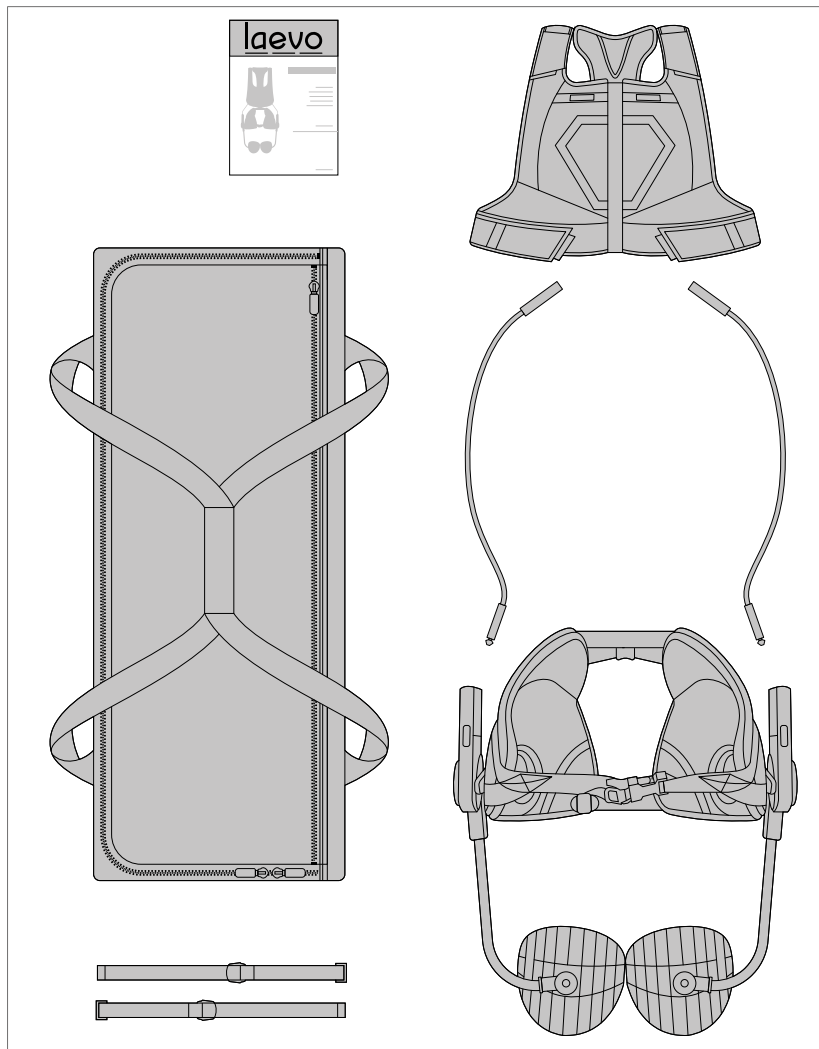

## 4. Preparation

### 4.1. Checking the contents of the box

- 1 Check that the box contains the following, at a minimum:
  - A vest assembly, which includes a front vest, the vest frame, the vest frame padding and the back connector;
  - Two torso structures;
  - A base assembly, which includes the hip frame, the hip padding and the leg pads;
  - Two leg straps, which can be attached later if preferred;
  - A bag to store the completely assembled FLEX and/or additional parts;
  - A quick-installation guide.
- ▶ If tools are necessary to install any additional parts you ordered, they are supplied:
  - An 8 mm hex key for the actuator springs
  - A 3 mm hex key for the leg pad fixator.

ⓘ **TIP:** No other tools are necessary to assemble the FLEX.

ⓘ **TIP:** Assemble the FLEX on a large, flat surface (for example, a table).

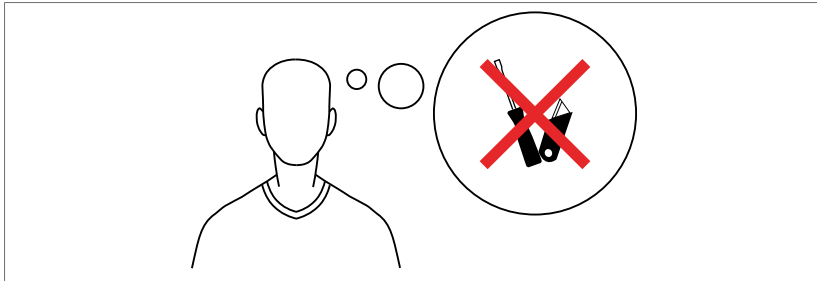

- 2 Go to [www.laevo-exoskeletons.com/register](http://www.laevo-exoskeletons.com/register)
- 3 Register the torso structures for more information and specific advice.

The serial number next to the date on the torso structure can be used to track these parts. Register the torso structures at [www.laevo-exoskeletons.com/register](http://www.laevo-exoskeletons.com/register) for specific advice on when to replace the structures.



## 4.2. Checking the part sizes

**TIP:** A custom FLEX that is not fitted for you can be uncomfortable.

- 1 Find which sizes you need. If the FLEX has been fitted before or the supplier has made recommendations, use those sizes.

Otherwise, refer to chapter [14](#), to determine the necessary sizes of the following parts:

- Front vest
  - Lower bar (of vest frame)
  - Leg pads
  - Actuator spring (its strength)
  - Torso structures
- 2 Check if the delivered parts are the correct size. The size of the parts can be found on the label (see table). Colour codes are shown in the tables.
  - 3 If you are not sure about correct sizes, check the Laevo website at [www.laevo-exoskeletons.com/flex-training](http://www.laevo-exoskeletons.com/flex-training) or contact Laevo or your supplier.

Go to [www.laevo-exoskeletons.com/flex-training](http://www.laevo-exoskeletons.com/flex-training)



**TIP:** Custom sized parts and exoskeletons are available.

XS	Extra small		orange
S	Small		yellow
M	Medium		red
L	Large		green
XL	Extra large		blue

UL	Ultra light		orange
L	Light		yellow
M	Medium		red
S	Strong		green
US	Ultra strong		blue

## 4.3. Labels and indications

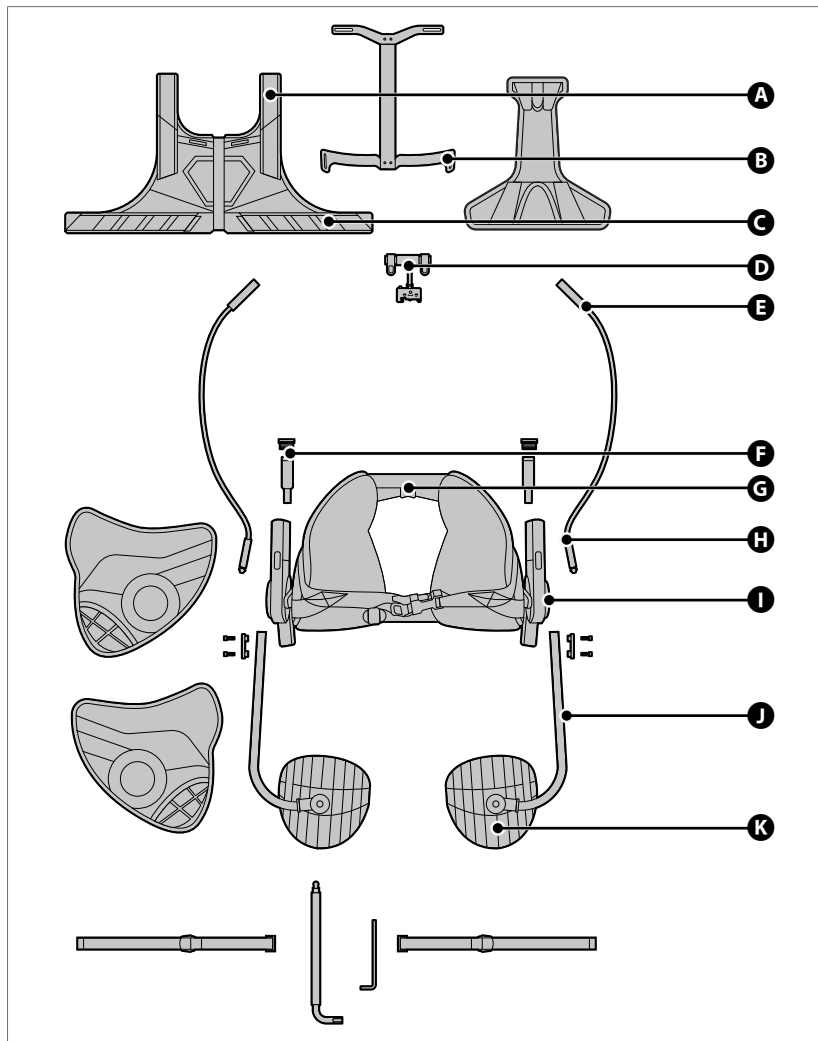



<b>A</b> Front vest	Size indication
<b>B</b> Lower bar (of vest frame)	Size indication
<b>C</b> Front vest	Name tag (inside)
<b>D</b> Back connector	Left-right indication
<b>E</b> Torso structure	Serial number Size indication
<b>F</b> Actuator spring	Label
<b>G</b> Hip frame	Strength indication
<b>H</b> Torso structure	Size indication
<b>I</b> Smart joint	Serial number Left-right indication
<b>J</b> Leg pad	Size indication
<b>K</b> Leg shells	Left-right indication

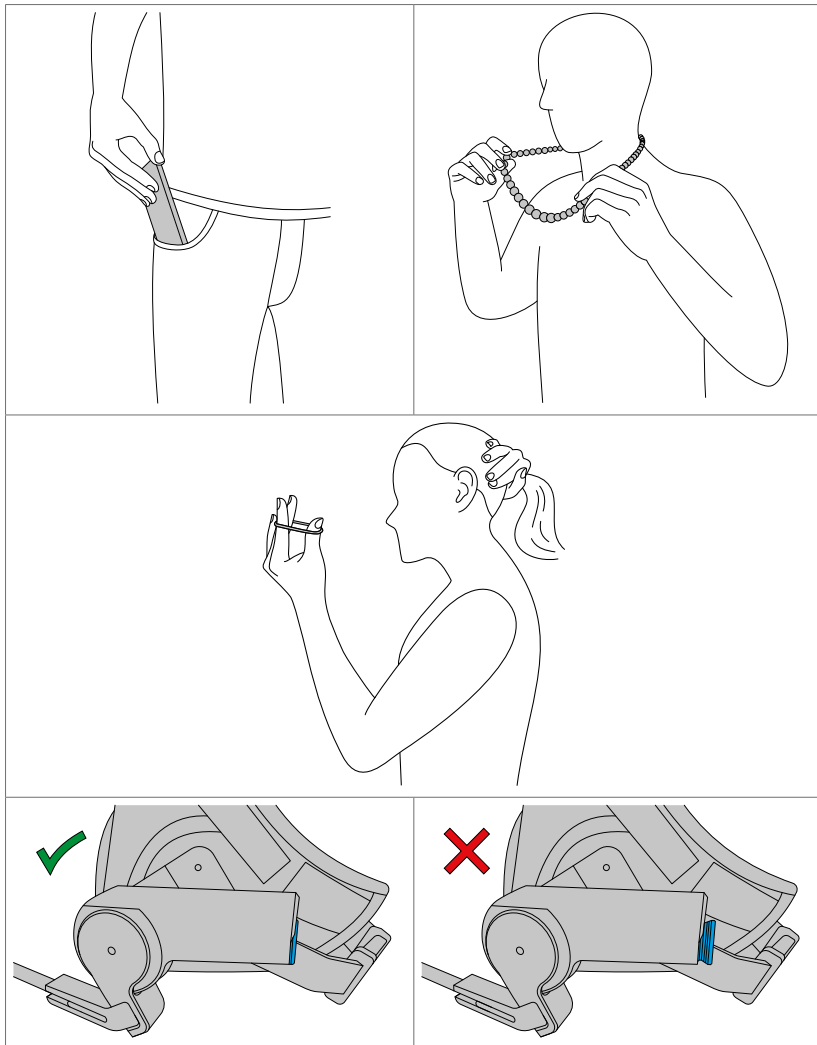

#### 4.4. Before use

 **TIP:** Make sure that you understand the safety instructions in chapter [3](#). Prepare as follows:

#### **WARNING!**

Never use the FLEX when the vest frame is damaged or bent. Check the vest frame for damage regularly.

- 1** Empty your pockets.
- 2** Remove uncomfortable accessories and clothing, for example, necklaces or scarves.
- 3** Long hair must be tied back.
- 4** Make sure that the screw caps that lock the actuator springs in the smart joints are tight.

Make sure that there is no visual damage or loose parts.

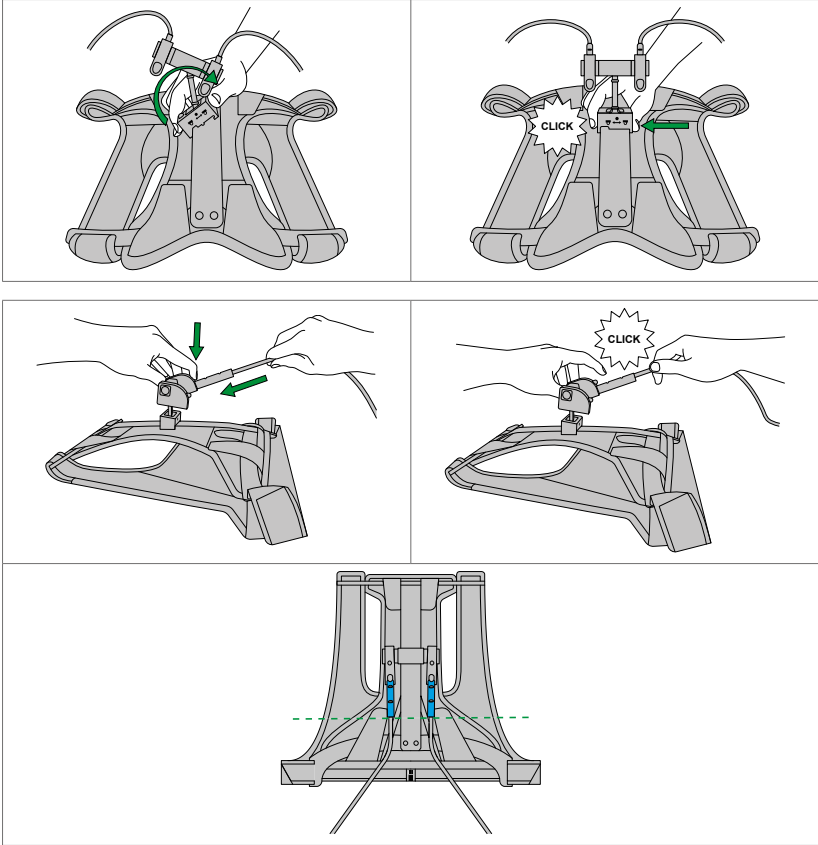

# 5. Installation

## 5.1. Connecting the back connector

If your back connector is already attached, skip this step.

- 1 Connect the back connector to the vest frame by tilting it around the vest frame into the hole.
- 2 Slide the back connector from left to right. An audible click means the back connector swivel is locked.

### **WARNING!**

Do not bend with the back connector unlocked.

#### **Risk of sudden loss of support**

- ▶ Pull lightly on the back connector in several directions to make sure that the back connector is locked.

## 5.2. Connecting the torso structures

- 1 Push the lock button of the torso structure on the right part of the back connector, which is labelled 'R'.

Put the right torso structure, labelled 'R', into the back connector. Slide it to the necessary length setting or use the middle setting.

- 2 Release the lock button. An audible click means the torso structure is locked.

Do these steps again for the left torso structure and the left part of the back connector, both labelled 'L'.

- 3 Check that left and right parts are set to the same length.

### **WARNING!**

Do not bend with the torso structures unlocked.

#### **Risk of sudden loss of support**

- ▶ Pull lightly on all structure ends to make sure all ends are locked.

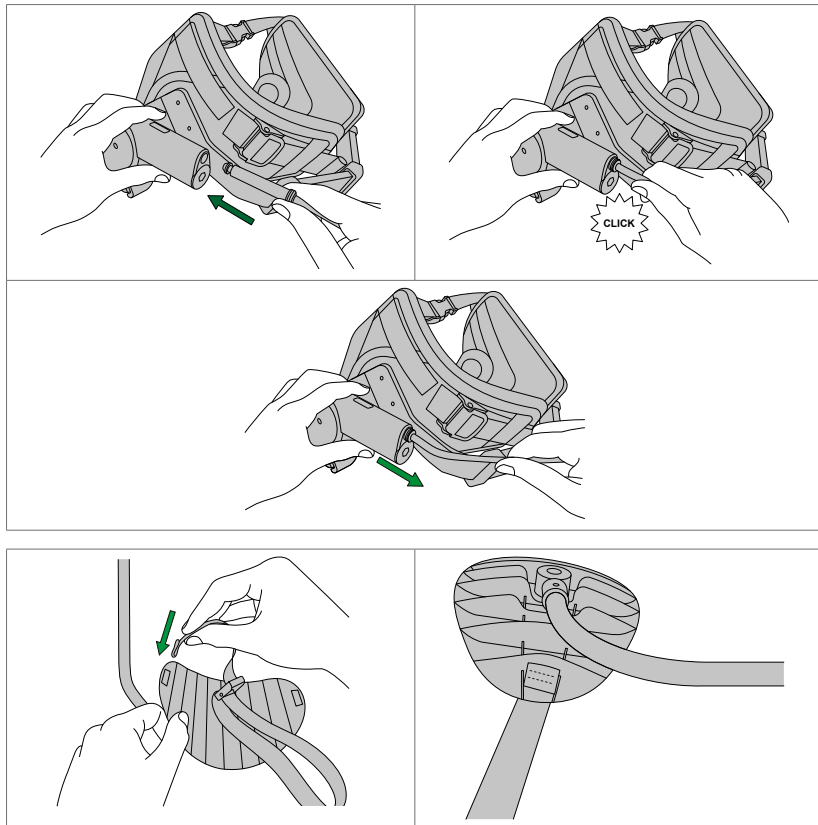

### 5.3. Connecting the torso structures to the hip frame

- 1 Put the left torso structure, labelled 'L', into the left smart joint, labelled 'L'.
- 2 An audible click means the torso structure is locked.
- 3 Pull lightly on the torso structure to make sure that it is locked.

Do these steps again for the right torso structure, labelled 'R'.

#### **WARNING!**

Do not bend with unlocked parts.

#### **Risk of sudden loss of support**

### 5.4. Installing the leg straps (optional)

The leg straps can help to keep the leg shells in place on your legs. To install them:

- 1 Make sure that the buckle on the leg strap is facing outward.
- 2 Put the end of the strap without the buckle through the slot in the leg shell.

### 5.5. Checking assembly

-  **TIP:** The installation is complete. See section [6.8](#). to learn how it should function after assembly.

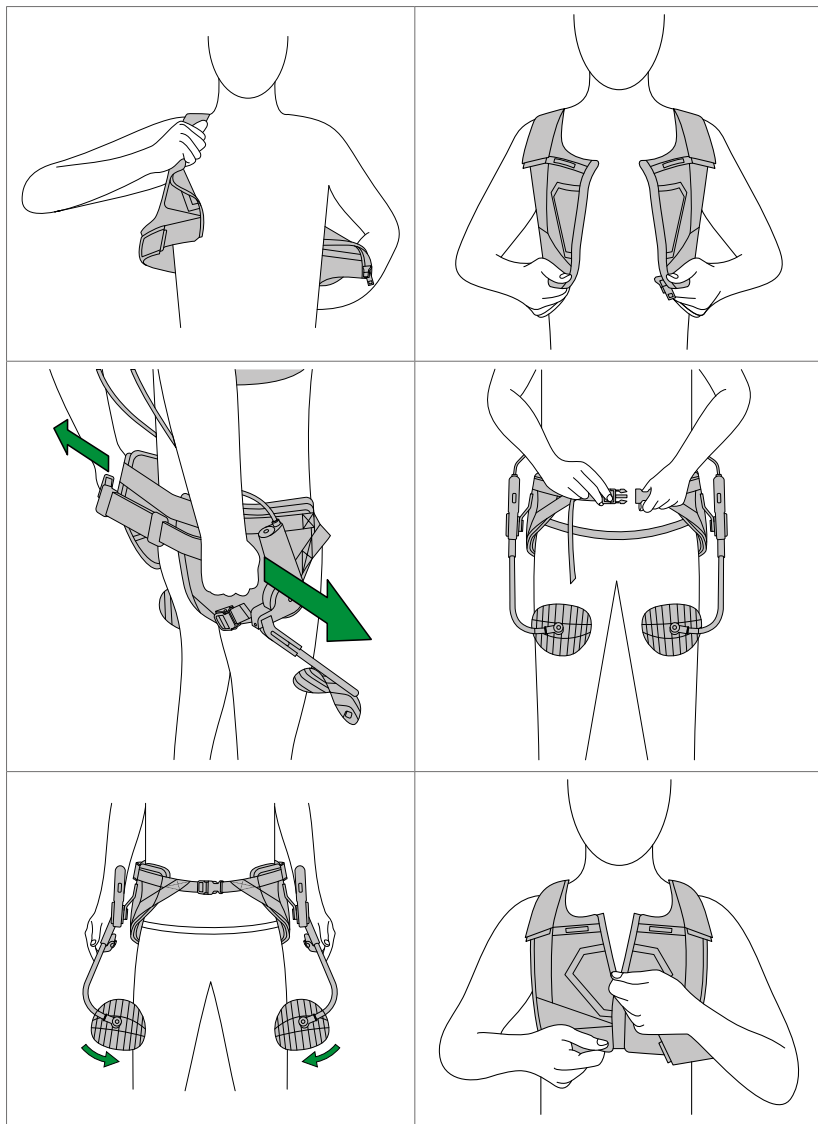



## 6. Fitting

Do the procedure in this chapter to adjust the FLEX to make it comfortable for you. After you wear it for several hours or days, adjust it again if necessary.

📌 **TIP:** All the adjustable parts of the FLEX are **coloured blue**.

### 6.1. Putting on and removing the FLEX

- 1 Put on the vest.
- 2 Do not close the vest.
- 3 Place the hip frame around your hips with the smart joints positioned on your hip joints. If necessary, tighten or loosen the upper back belt and bottom belt of the hip frame. See section [6.3](#) for additional fitting instructions.
- 4 Close the front belt.
- 5 Put the leg shells on your thighs.
- 6 Close the zipper of the vest.

To remove the FLEX, do these steps in the reverse order.

📌 **TIP:** You can change upper body clothing while you wear the hip frame. You only need to remove the vest.

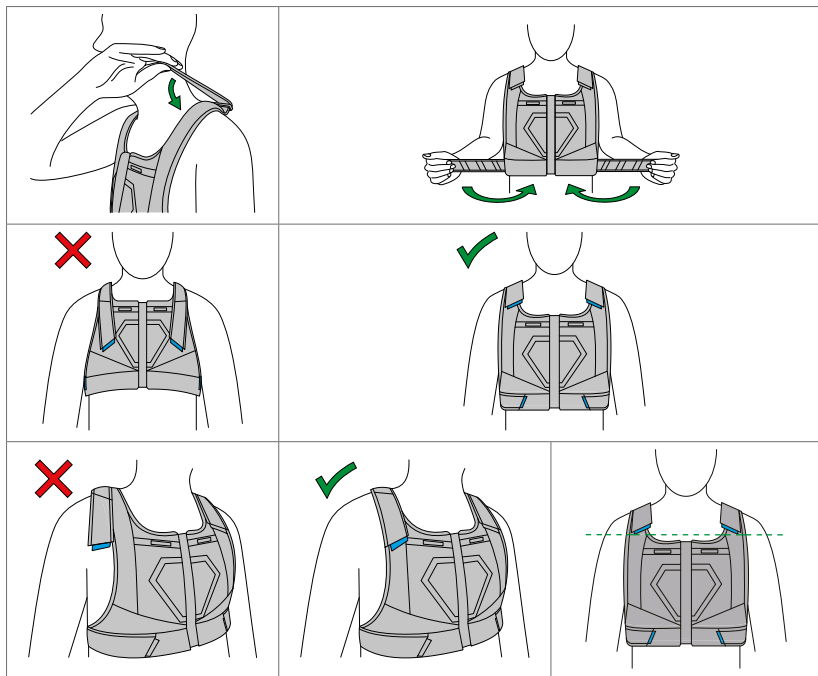

## 6.2. Adjusting the front vest

- 1 Set the straps to a long, loose fit.
- 2 Put on the vest.
- 3 Close the zipper.
- 4 Take a semi-deep breath.
- 5 Tighten the lower front vest straps to a comfortable setting.
- 6 Tighten the upper front vest straps to a comfortable setting.
- 7 Wear the vest at a comfortable height. Check that:
  - The vest covers your sternum
  - The vest does not press your stomach
  - The vest allows you to reach forward comfortably
  - The vest does not cut into your neck.
- 8 Make sure that:
  - The end of the strap overlaps the Velcro of the vest
  - You can breathe comfortably
  - The left and right vest straps are the same length.

### **WARNING!**

Be careful that the Velcro does not loosen under a load.

#### **Risk of sudden loss of support**

- ▶ Check that the Velcro is attached correctly.

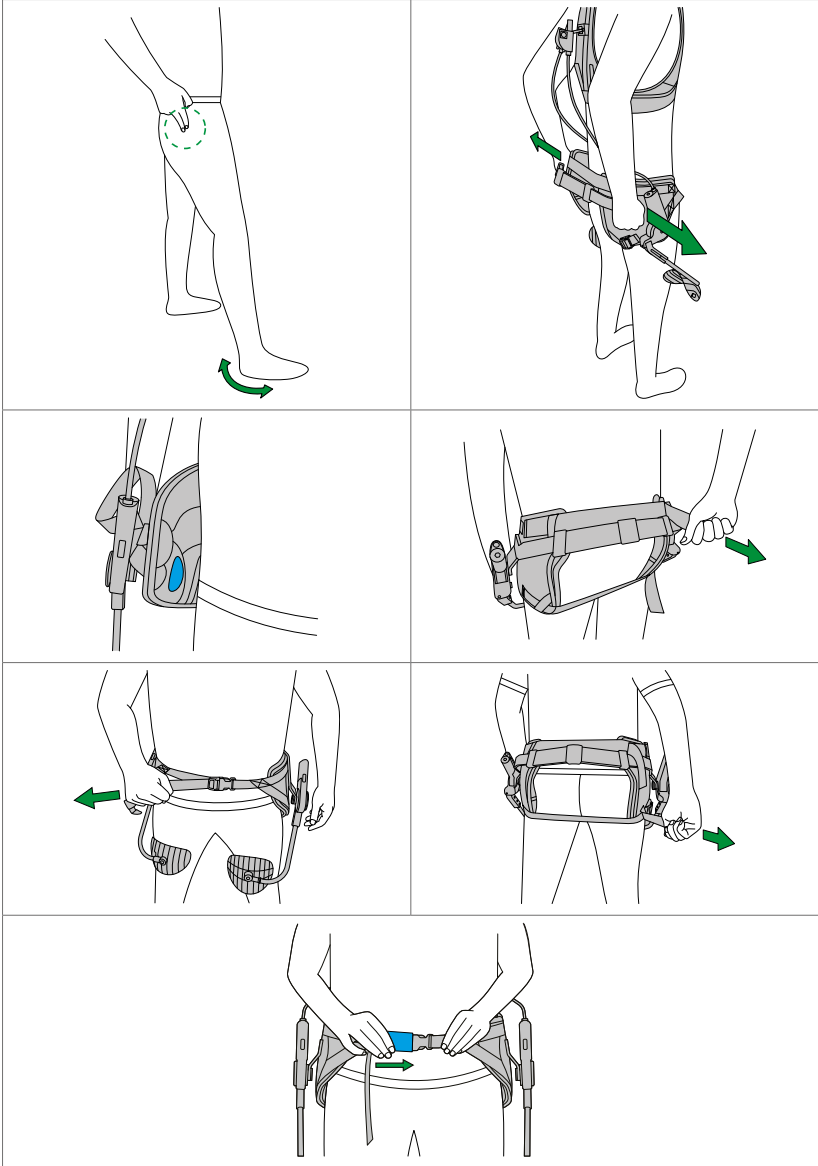

### 6.3. Aligning the hip frame and smart joints

- 1 Feel where your hip joint (the bone part that can be felt on the outside) is located by turning your heel on the ground.
- 2 Loosen all the belts of the hip frame.
- 3 Put on the hip frame. Pull outward to widen the frame.
- 4 To adjust the belts and position the smart joint, you must:
  - Have no torso structures connected, or
  - Set the smart joint angle to the highest value.
- 5 Put the smart joints on your hip joints. Put the round indication on the hip padding over your hip joint (the bone part that can be felt on the outside).
- 6 Tighten the upper back belt until it presses against your back.
- 7 Tighten the front belt.
- 8 Get into a semi-squat position / bend your knees and slightly tighten the bottom belt.
- 9 Stand straight.
- 10 Raise one leg and examine the smart joints to make sure that they are aligned with your hip joints.
- 11 Move the sleeve over the front buckle.

ⓘ **NOTE:** If the smart joints are in position on your hip joints, the leg shells will move on your thighs during movement.

ⓘ **TIP:** If the smart joint is above your hip joint, loosen the front belt and lower the hip frame. Tighten the front belt.

ⓘ **TIP:** If the smart joint is in front of your hip joint, loosen the front belt and tighten the upper back belt and bottom belt. Tighten the front belt.

ⓘ **TIP:** If the smart joint is behind your hip joint, loosen the upper back belt and bottom belt. Tighten the front belt.

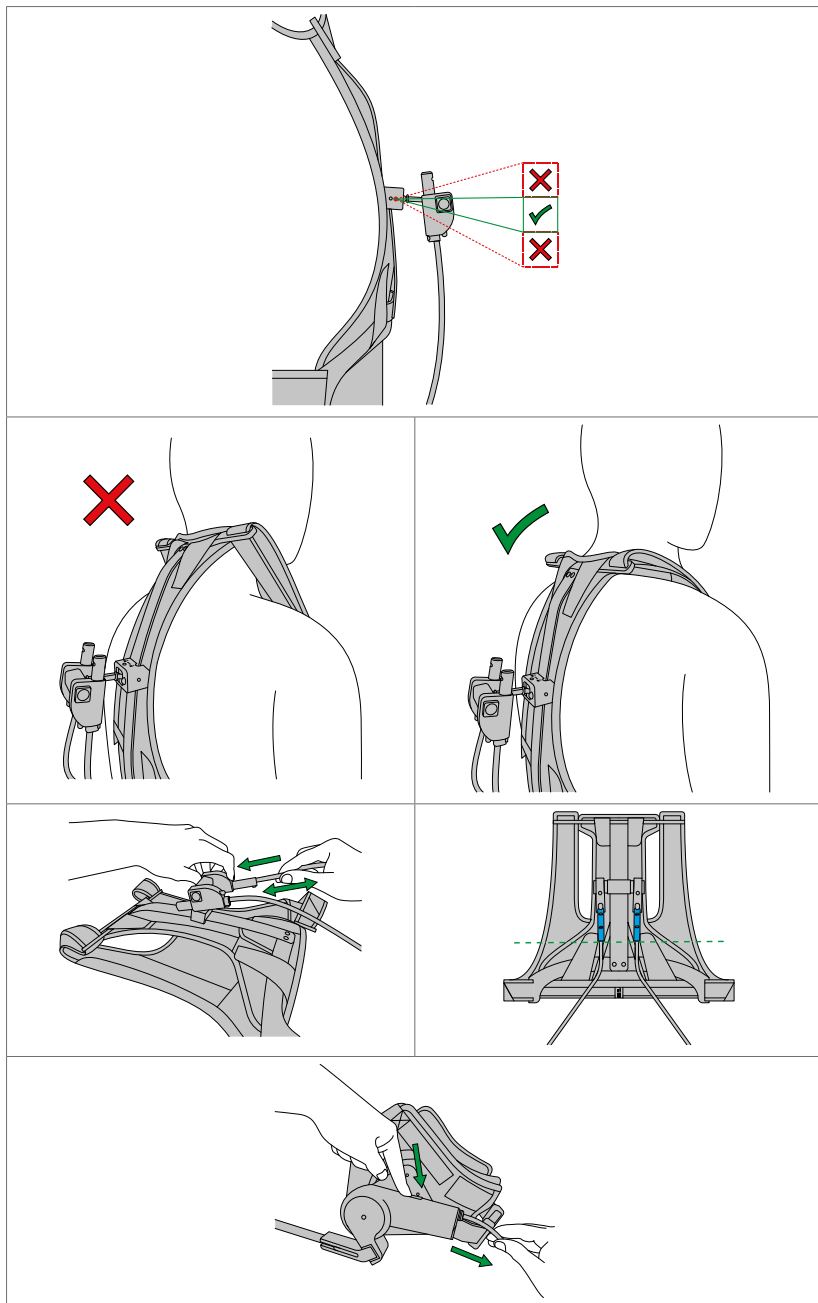

#### 6.4. Adjusting the length of the torso structure

- 1 Stand straight and relaxed, with the FLEX on your body.
- 2 From the side, check the angle of the back connector swivel. Use a mirror, take a photo or have someone assist you.
- 3 The swivel arm (for back connector) must be horizontal or point slightly downward.
- 4 Feel if your vest is being pushed up or pulled down.
  - The vest must not be pushed up.
  - The vest must not be pulled down, because this will cause pressure and discomfort on the front or top of the shoulder.

The following steps can be done with someone helping you or when the FLEX is not worn.

If the swivel arm points down and pulls the vest down:

- 5 Adjust the torso structure lengths to a larger setting (see section [5.2.](#)) or select a larger torso structure size (see chapter [11.](#)).
- 6 Make sure that the height setting is the same on the left and right sides.

If the swivel arm points up and pushes the vest up:

- 7 Adjust the torso structure lengths to a shorter setting (see section [5.2.](#)) or select a smaller torso structure size (see chapter [11.](#)).
- 8 Make sure that the height setting is the same on the left and right sides.

ⓘ **TIP:** Push the button on the smart joint and remove the torso structure from the smart joint to make it easier to adjust the length settings.

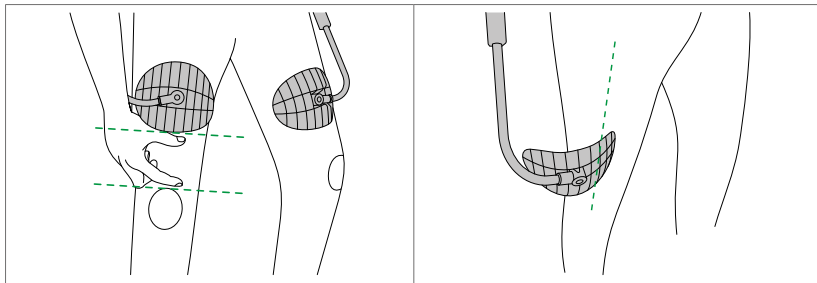



## 6.5. Fitting the leg pads

- ⓘ **NOTE:** Make sure that the smart joints are on your hip joints (section [6.3.](#)) before you adjust the length of the leg pads.
- 1 Make sure that the leg shells push on the legs while slightly stooped.
  - 2 The lower rim of the leg shells must be above the kneecaps. The recommended distance is 2 to 5 cm.
  - 3 Adjust the length of the leg pads to a larger setting or select a larger leg pad size (chapter [14.](#)) if:
    - The leg shells are far above the knees and cause discomfort.
  - 4 Adjust the length of the leg pads to a smaller setting or select a smaller leg pad size (chapter [14.](#)) if:
    - The leg shells are on the knees, and
    - You have knee problems or experience discomfort.
  - 5 Attach leg straps (sections [5.4.](#) and [6.6.](#)) if:
    - The leg shells are not centred side to side on the thighs, and
    - The leg shells move sideways during use and cause discomfort.
- ⓘ **TIP:** If your size is not included in your package, contact your Laevo supplier.

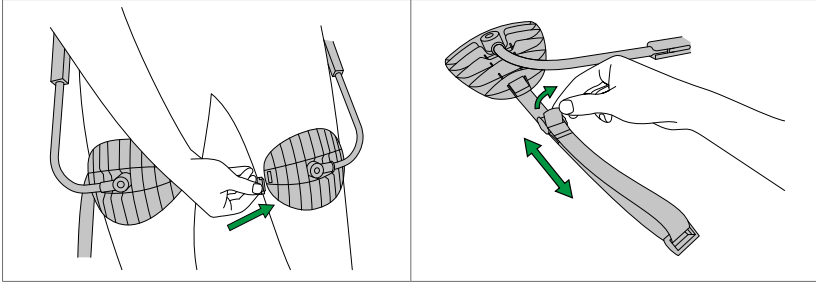

## 6.6. Fitting the leg straps (optional)

The leg straps can help to keep the leg shells in place on your leg. To fit them correctly:

- 1 Put the leg shell in a comfortable position on your leg.
- 2 Use the clip on the leg strap to connect the leg strap to the leg shell.
- 3 Pull on the end of the leg strap to tighten the leg strap.
- 4 To remove the leg strap, disconnect the clip from the leg shell.

ⓘ **TIP:** If the leg straps are too loose, they will not stay in position. Find a setting that is comfortable.

ⓘ **TIP:** If the leg straps are too tight, they will be uncomfortable. Find a setting that is comfortable.

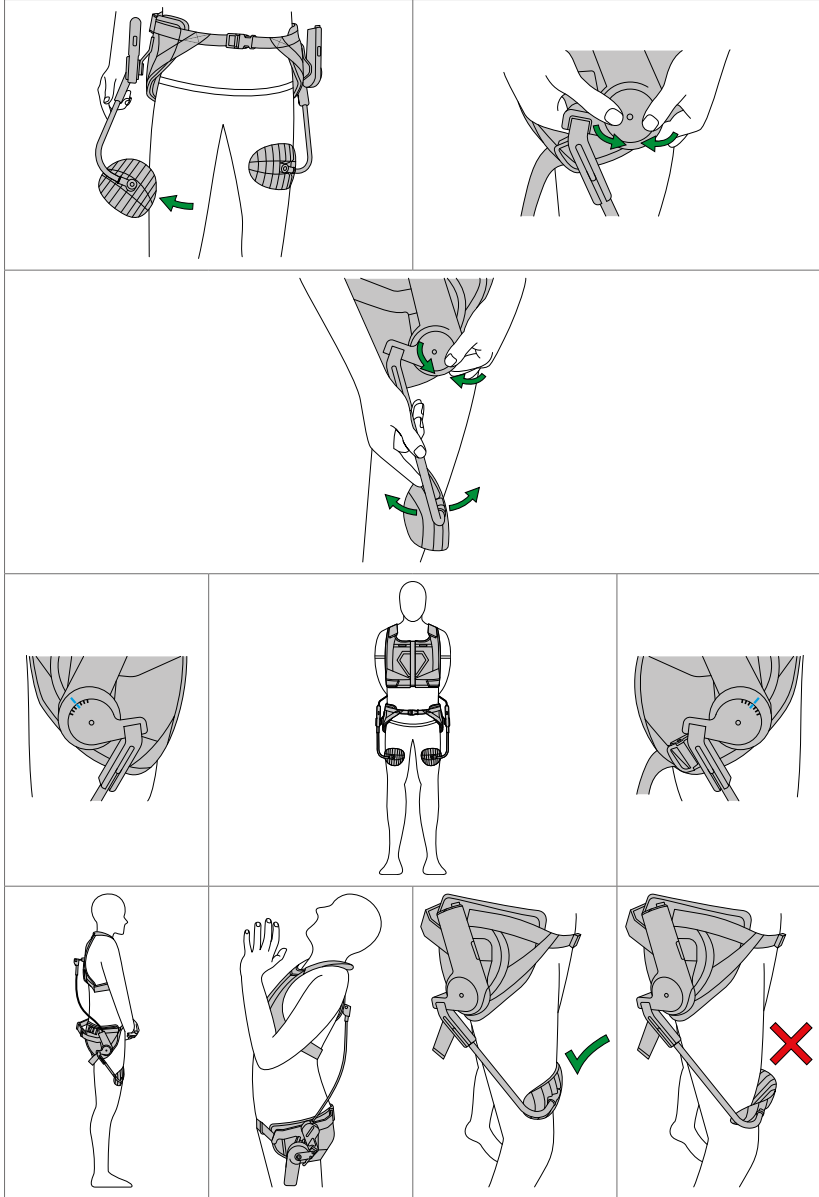

## 6.7. Setting the angle of the smart joint

Seven settings are available for the angle of the smart joint. Setting 1 is the loosest setting, which gives more freedom to walk. Setting 7 is the tightest setting, which gives support sooner.

- 1 Stand in a natural, straight position.
- 2 Turn the leg pads off your thighs.
- 3 Squeeze the smart joint to unlock the angle setting.
- 4 While you squeeze the smart joint, turn the leg pad.
- 5 Release the smart joint. An audible click means the angle setting is locked.

Do these steps again for the other smart joint.

- 6 While there is no pressure on either leg, make sure that the setting for the angle of the smart joint is the same on both sides.
- 7 Put the leg pads back on your thighs.

**ⓘ TIP:** It can be necessary to change the angle setting for each person and each task. Choose the setting that is most comfortable for you.

- Do this if you prefer a tight setting: lean backward slightly, as if there is a force against your chest.
  - Do this if you prefer a loose setting: stand straight, in a comfortable position.
- 8 Adjust to a comfortable setting.
    - If the leg shells lift off of your thighs, do steps 1-6 and set the angle of the smart joint to a higher setting.
    - If the leg shells press uncomfortably on your thighs, do steps 1-6 and set the angle of the smart joint to a lower setting.

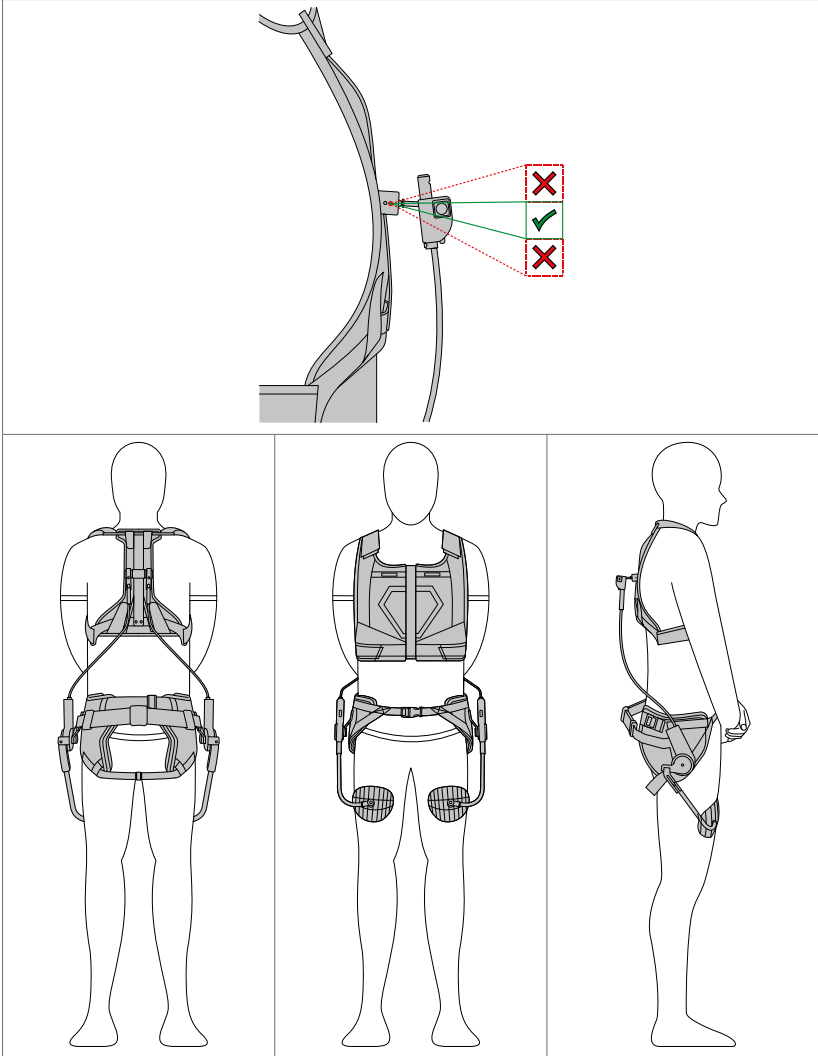

### 6.8. How a good fit looks and feels

- 1 Stand straight but relaxed. Examine the following:
    - The swivel arm must be horizontal or point slightly downward.
    - The left and right sides are approximately symmetrical.
    - The back connector swivel is horizontal.
    - The vest straps are adjusted symmetrically.
    - The remaining length of the belt is rolled up.
    - The buckle of the front belt is covered by the front belt sleeve.
  - 2 Feel the following:
    - The smart joints are on your hip joints.
    - The leg shells press slightly on your thighs or lift off your thighs slightly.
    - The hip frame feels secure. The hip frame does not press uncomfortably.
    - All belts of the hip frame are tight.
    - The vest feels secure. The vest does not press the chest uncomfortably.
    - Your arms can move freely.
- ⓘ **TIP:** If you think the FLEX does not fit your body well, contact your Laevo supplier

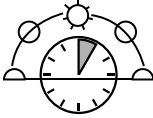
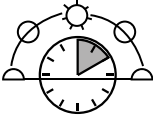
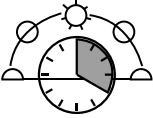
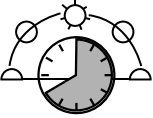
Day 1	Day 2	Day 3	Day 4
max. 1 hr	max. 2 hr	max. 4 hr	max. 8 hr
			



# 7. Using the FLEX

## 7.1. Learn to use the FLEX

It takes time to learn to use the FLEX comfortably and effectively.

Gradually increase use of the FLEX: from one hour a day, to two hours a day, to four hours a day, up to the maximum of eight hours a day.

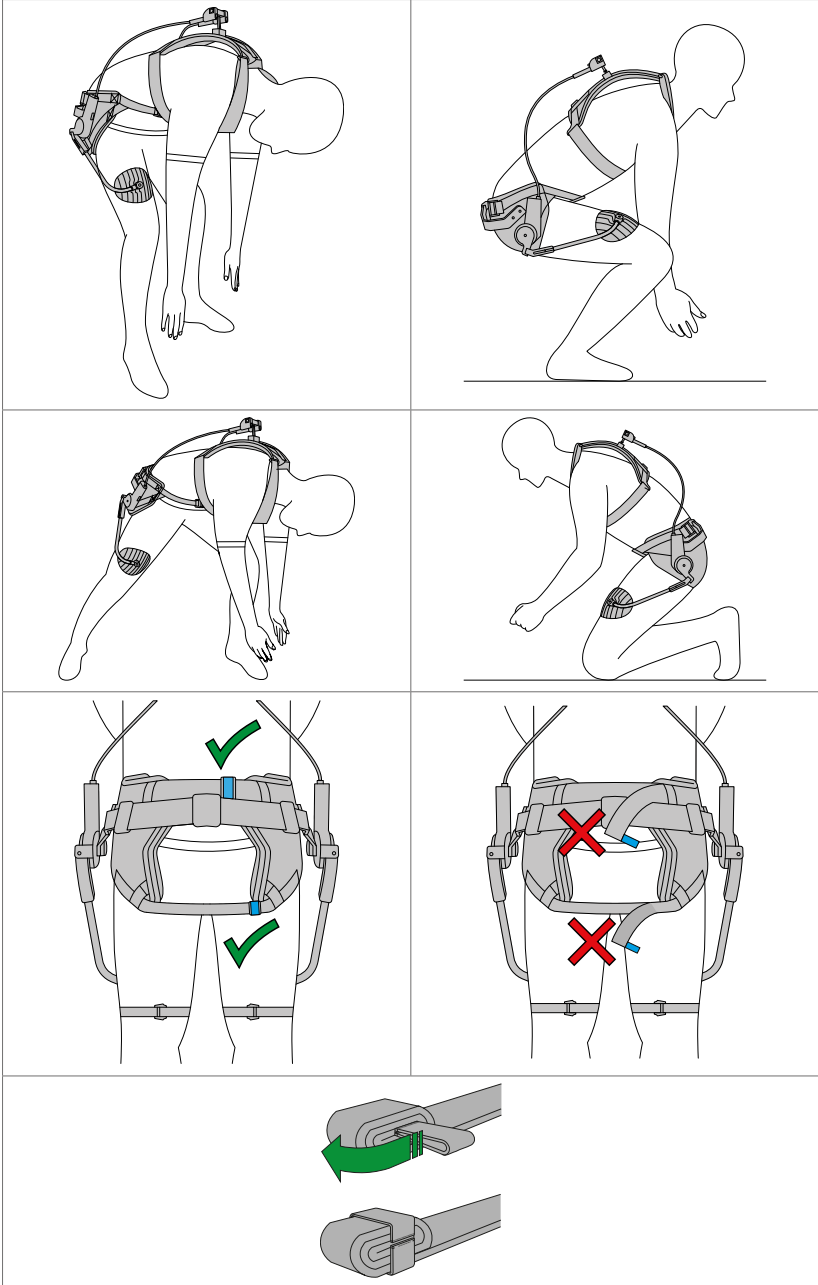

## 7.2. First movements with the FLEX

The first time you use the FLEX, carefully make the following movements:

- 1 Stoop: Bend forward from the hips, reach toward your toes and stand upright again.
- 2 Squat: Bend your knees and stand upright again.
- 3 Sideways stoop: Bend sideways and stretch your arms.
- 4 Kneel: Kneel and move around.

If the movements above are not comfortable and easy:

- Do the fitting process again.
- Contact your supplier.

## 7.3. Lock and stow the belt straps

To keep the belt settings, lock the buckles:

- 1 Slide the front belt sleeve over the buckle of the front belt.

Stow remaining length of the belt strap:

- 2 Roll up any remaining length. Stow it in the elastic loop at the end of the belt.

### **WARNING!**

Loose belts can get caught

#### **Risk of entrapment**

- 3 For all belts, make sure that the remaining length is stowed or cut off.

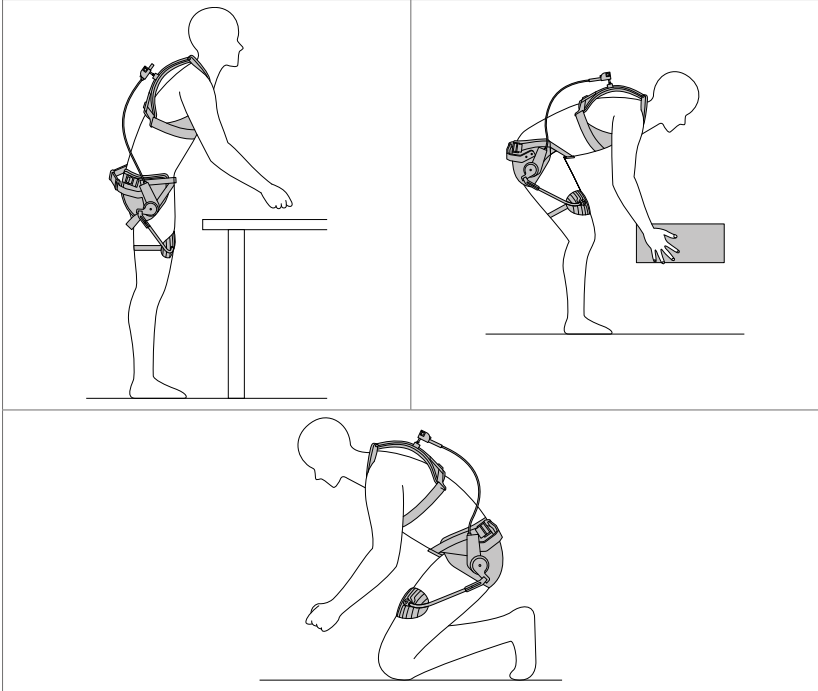

## 8. Daily use

### 8.1. Adjust the angle of the smart joint to the task

Change the angle of the smart joint as necessary for the task.

Use a small angle (higher number) if you want fast, direct support, for example, for tabletop work.

Use a high angle (lower number) if you want no support when upright or slightly stooped, for example, for walking and deep lifts.

See section [6.7](#) for how to adjust the angle of the smart joint.

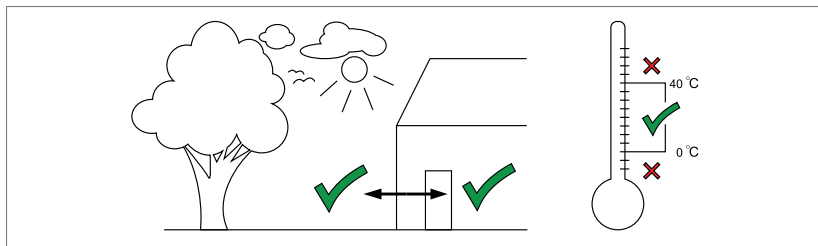

## 8.2. Where to use the FLEX

The FLEX is for indoor and outdoor use.

- ⓘ **NOTE:** The FLEX may not be stored in direct sunlight.
- ⓘ **NOTE:** The FLEX may not be used in a setting where the ambient temperature is lower than 0 °C or higher than 40 °C.

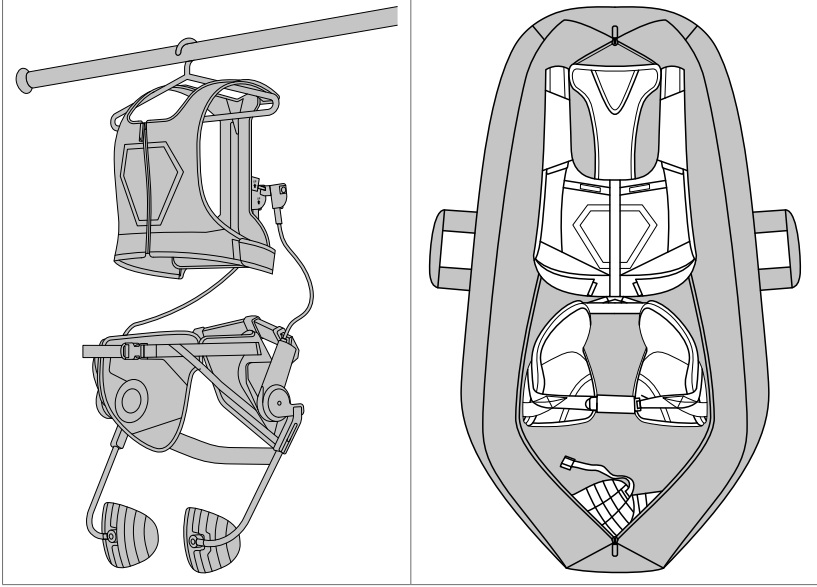



## 9. Storage and transport

Store in a dry place.

① **TIP:** Hang for storage.

- 1 Close the vest and the front hip belt.
- 2 To store the FLEX on a coat rack, put it on a coat hanger or put it in its bag.

Always store and transport the FLEX within the conditions for use as described in chapter [13](#), Specifications.

# 10. Troubleshooting

<b>Problem</b>	<b>Possible cause</b>	<b>Possible solution</b>
The vertical bar of the vest frame is bent in upright position.	The vertical bar is damaged	Replace the vest frame
The settings of the FLEX can not be adjusted	There is too much tension on the system.	Make sure you are in an upright position to adjust the settings. Take off the FLEX to adjust the settings.

# 11. Maintenance

- ⓘ TIP:** This chapter describes all maintenance that can be done by an unskilled end user.
- Contact your supplier for other maintenance.

## 11.1. Life span of the Laevo FLEX

The life span of the FLEX depends on the amount of usage and the period of usage.

### **⚠ WARNING!**

Never use the FLEX when the vest frame is damaged or bent. Check the vest frame for damage regularly.

Actuator spring	Life span
Ultra light	250.000 cycles
Light	3 years of use
Medium	
Strong	
Ultra strong	The FLEX with the ultra-strong actuator spring may have a reduced life span. Contact your Laevo supplier for more information.

The serial number next to the date on the torso structure can be used to track these parts. Register the torso structures at [www.laevo-exoskeletons.com/register](http://www.laevo-exoskeletons.com/register) for specific advice on when to replace the structures.



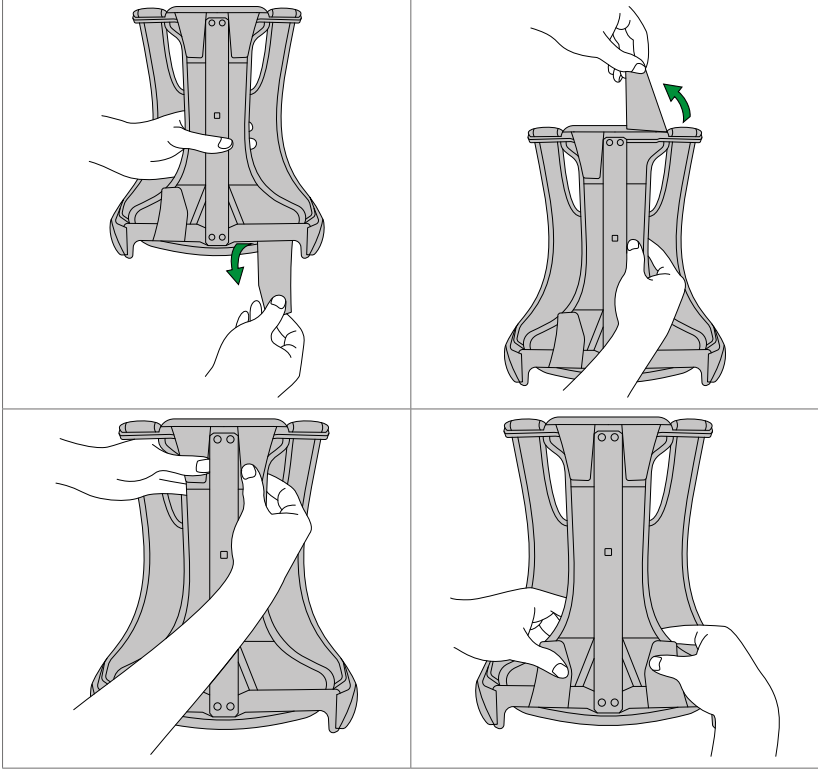

## 11.2. Replacing the vest frame padding

To remove:

- 1 Open the Velcro of the bottom of the vest padding.
- 2 Open the Velcro of the top of the vest padding.
- 3 Remove the vest padding from the vest frame.

To install:

- 1 Attach the vest frame padding to the top of the vest frame.
- 2 Attach the vest frame padding to the bottom of the vest frame.
- 3 Close the Velcro.

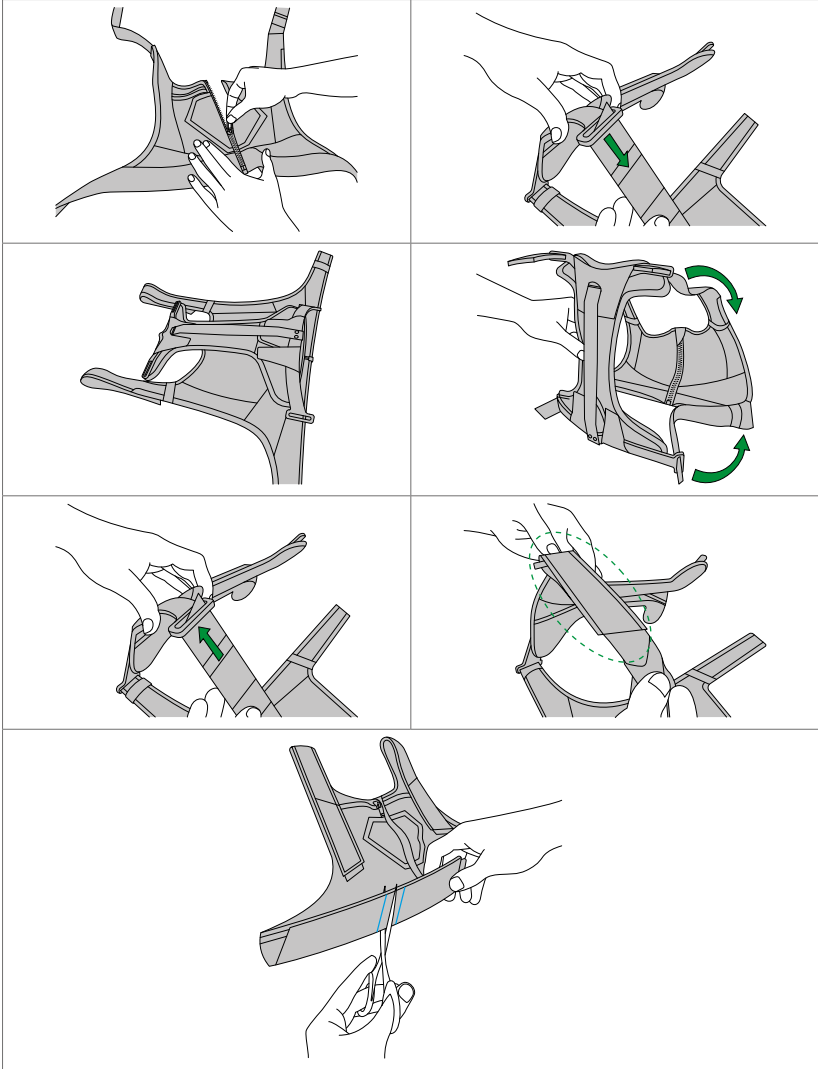

### 11.3. Replacing the front vest

To remove:

- 1 Close the zipper of the front vest.
- 2 Open the Velcro of the front vest straps.
- 3 Remove the front vest straps from the slots of the vest frame.

To install:

- 1 Put the wide (lower) end of the front vest over the wide (lower) end of the vest frame.
- 2 Put the straps of a new front vest in the slots of the vest frame.
- 3 Close the Velcro of the front vest straps.
- 4 Make sure that the Velcro has a minimum overlap of 10 cm.

ⓘ **TIP:** Make sure that the name tag is on the inside of the vest, against the body.

If the straps are on the zipper:

- 1 Cut the straps of the front vest at the blue lines (optional).

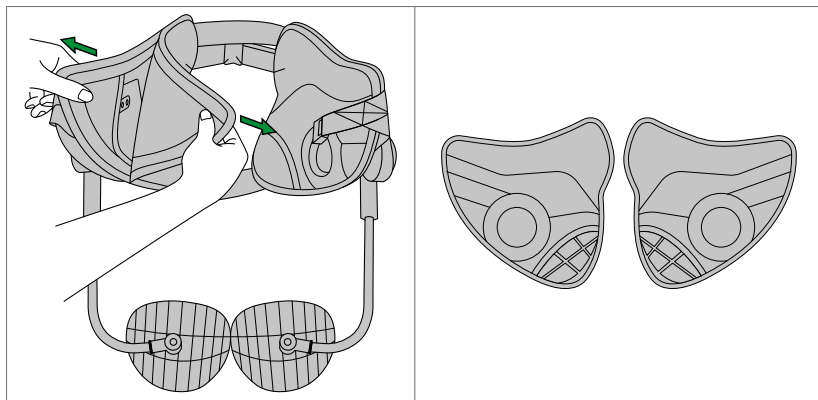



#### 11.4. Replacing the hip padding

The padding on the hips is attached with Velcro. To remove the padding:

- 1 Pull the hip frame padding off the hip frame.
- 2 Replace with new padding.

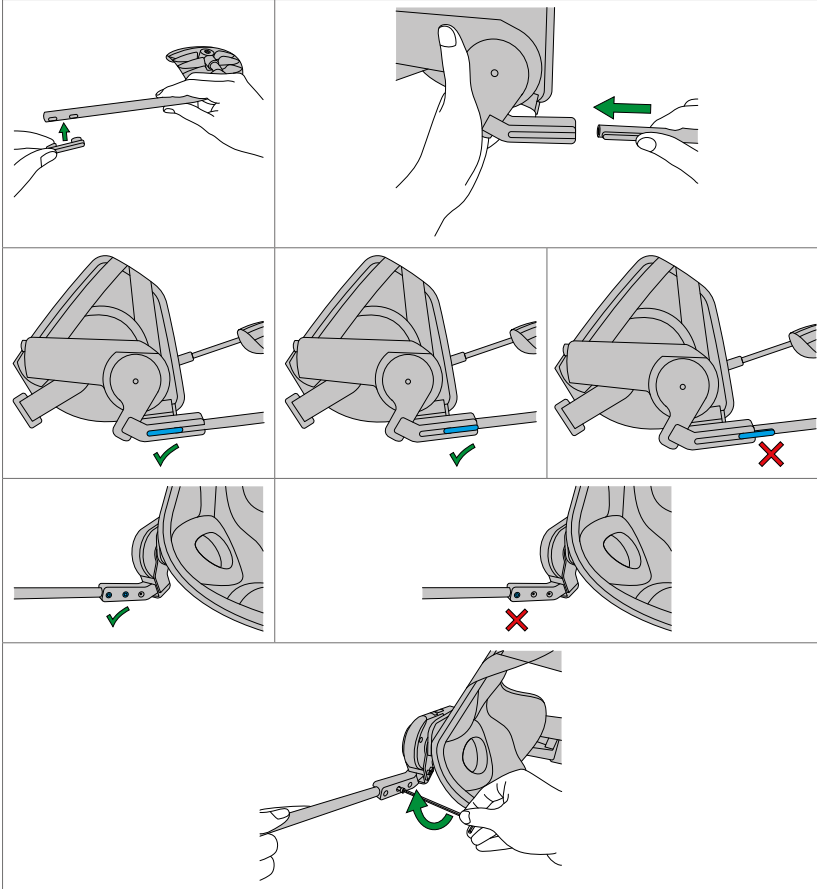

### 11.5. Replacing the leg pads

The length of the leg pads can be adjusted by attaching them to the upper or lower length setting.

#### **⚠ WARNING!**

Always use two screws to attach each leg pad to the smart joint!

- 1** Identify the right leg pad. The right leg pad forms an 'L' when seen from the front.
- 2** Put the leg pad fixator in the slots of the leg pad.
- 3** Put the leg pad fixator in the slot of the right smart joint.
- 4** Move the leg pad to the upper or lower setting in the smart joint.
  - Start with the leg pads all the way in.
- 5** Put two screws in the two holes of the smart joint.
- 6** Use a 3 mm hex key to tighten until the screw heads contact the smart joint.

Do these steps again for the left leg pad.

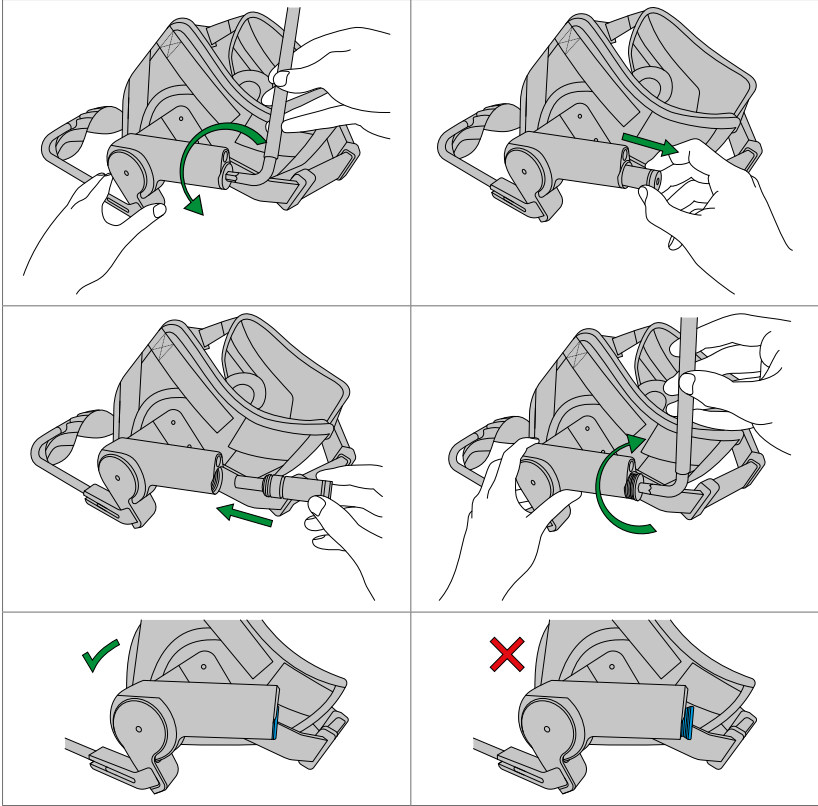

### 11.6. Replacing the actuator springs

- 1 Use an 8 mm hex key to remove the cap from the smart joint.
- 2 Remove the actuator spring from the smart joint.
- 3 Put the actuator spring in the smart joint. You can find the actuator spring strength using the sizing tool (see chapter [14.](#)).
- 4 Put the cap in the hole at the top of the smart joint.
- 5 Use the supplied 8 mm hex key to tighten until the cap head contacts the smart joint.
- 6 Check that the cap head closes fully.

Do these steps again for the other actuator spring.

#### **WARNING!**

Support that is not symmetrical

**Risk of discomfort and load on body and exoskeleton parts that is not symmetrical**

- ▶ Always replace the actuator springs on both sides at the same time. Laevo supplies actuator springs as a pair that have the same strength.

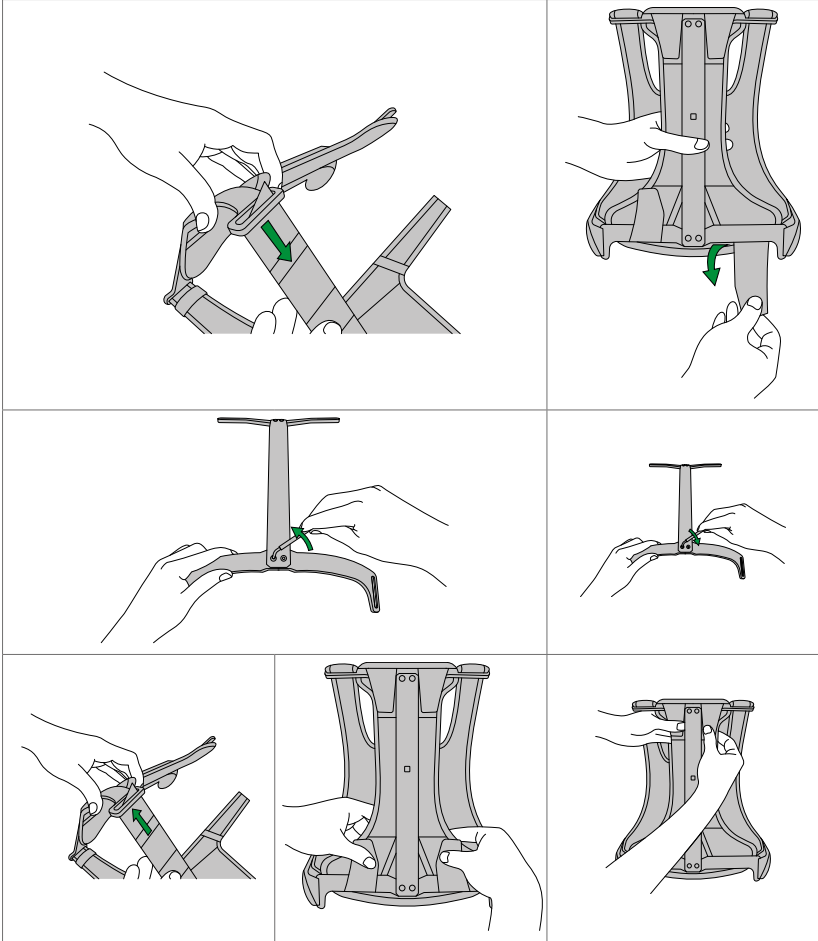

### 11.7. Replacing the lower bar

To remove:

- 1 Remove the front vest and the back padding from the vest frame.
- 2 Use a Torx T20 screwdriver to loosen the two screws of the lower bar.

To install:

- 1 Put the two screws of the lower bar in the two holes.
- 2 Use a Torx T20 screwdriver to tighten the two screws.
- 3 Use the Velcro to attach the front vest and the back padding to the vest frame.

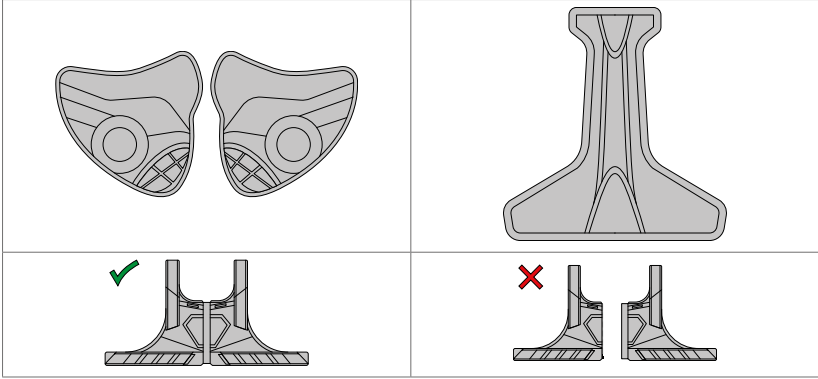



### 11.8. Washing and cleaning

To clean the FLEX:

- 1 Remove the hip padding.
- 2 Remove the vest frame padding.
- 3 Remove the front vest.
- 4 Use a moist cloth, lukewarm/hot water and a mild cleaning product. Do not use solvents (or cleaning products that contain solvents), bleach, polisher or detergent.

To clean the front vest, the vest frame padding and the hip padding:

- 1 Remove the front vest, the vest frame padding and the hip padding from the FLEX.
- 2 Zip the two halves of the front vest together.
- 3 Wash the front vest, the vest frame padding and the hip padding at a maximum temperature of 30 °C. Use only the hand wash cycle.

### 11.9. Check regularly

Check regularly:

- For visible damage, for example a bent vest frame.
- That all parts are still securely attached without play.
- For the correct operation of the adjustments and buttons.

### 11.10. Repair and disposal

At the end of its working life this equipment must not be disposed of as a household waste. Contact your supplier for details on how to dispose of this product properly.

# 12. Legal information

## 12.1. Liability

Laevo B.V. cannot be held liable for: [a] Personal injury or damage to property when a user or third party does not follow the recommendations and warnings in this manual, [b] damage when changes are made to the original product, [c] wear and damage when the user has not used the product correctly, [d] damage when non-original replacement parts have been used.

## 12.2. Warranty

The product is covered by the Laevo Business Warranty. It can be found at [www.laevo-exoskeletons.com/legal](http://www.laevo-exoskeletons.com/legal). Contact Laevo or your supplier to get a printed version.

Any changes and/or modifications to the product will void warranty.

## 12.3. CE

This product meets the requirements of European Regulation (EU) 2016/425 on personal protective equipment. This product has been classified as a class II device according to the classification criteria outlined in annex IX of the directive. The notified body that assessed this product:

RICOTEST notified body no. 0498 Via Tione, 9 37010 Pastrengo Verona, Italy	
--	--



The declaration of conformity can be found at [www.laevo-exoskeletons.com/legal](http://www.laevo-exoskeletons.com/legal).

The contact information for Laevo BV, the legal manufacturer, is in section [1.4.](#)

# 13. Specifications

## 13.1. Technical specifications Laevo FLEX

<b>Product name:</b>	Laevo FLEX V3.0
<b>Product numbers:</b>	V3.0 and higher
<b>Weight:</b>	4.0-4.4 kg 4.2 kg medium sized-parts
<b>Serial number:</b>	See label (on hip frame)
<b>CE certification:</b>	Personal Protective Equipment Class II
<b>Expected lifetime</b>	250.000 bends or 3 years
<b>Materials used:</b>	Vest: Synthetic fabrics Hip padding: Synthetic fabrics Leg shells: Polypropylene Frame: Anodized aluminium, steel, nitrogen gas spring

Table: Laevo FLEX V3.0 specifications (assembled)

## 13.2. Technical specifications Torso Structures

<b>Product name:</b>	Laevo FLEX V3.0
<b>Product numbers:</b>	V3.0 and higher
<b>Serial number:</b>	See top end
<b>Expiry date:</b>	See top end
<b>Materials used:</b>	Powder coated steel, aluminium

Table: Laevo torso structures

## 14. Sizing tool

The Laevo FLEX can be adjusted to size. Parts in multiple sizes are available. For more information, please find our sizing tool at [www.laevo-exoskeletons.com/flex-training](http://www.laevo-exoskeletons.com/flex-training)







**Laevo BV.**

Patrijsweg 30  
2289 EX, Rijswijk,  
The Netherlands

[www.laevo-exoskeletons.com](http://www.laevo-exoskeletons.com)

+31 15 30 20 025